

IQ3 Street Dash Installation Manual



Disclaimer

Racepak LLC makes no representations or warranties of any type with respect to the contents in this manual. Racepak LLC disclaims any implied warranties or fitness for any particular purpose. Racepak LLC is not liable for any errors contained within or for incidental or consequential damages in connection with the supply, performance or use of the hardware and software or this manual.

Racepak LLC reserves the right to revise this installation and user manual at any time, without obligation to notify any person of revisions. As defined by the Magnuson-Moss warranty Act, do not install any parts or services unless you have the technical ability to properly set-up the entire vehicle to compensate for the installation of those parts. The necessary work and expertise needed to install different products varies. Instructions, where provided, are given to assist in the installation only; they are not a substitute for mechanical experience in setting up vehicles. Racepak LLC is not responsible for any personal or property damages caused by the installation of this product.

Warranty

Racepak LLC makes every effort to ensure our products and services are of the highest quality and standards. It is our intention to maintain a mutually beneficial and cordial relationship with each and every customer.

Racepak LLC warrants all merchandise manufactured by Racepak LLC against defects in workmanship or material for a period of six (6) months after the date of purchase. This warranty applies to the first retail purchaser and covers only those products exposed to normal use or service. It does not apply to those products used for a purpose for which said products were not designed, or which has been altered in any way that would be detrimental to the performance or life of the product, or misapplication, misuse, negligence, or accident. Any part or product found to be defective after examination by Racepak LLC will be repaired or replaced. Racepak LLC assumes no responsibility for diagnosis, removal and/or installation labor, loss of vehicle use, loss of time, inconvenience or any other consequential expenses.

This warranty is in lieu of any other expressed or implied warranties, including any implied warranty or merchantability or fitness, and any other obligation on the part of Racepak LLC, or selling dealer.

If you have any questions regarding warranty, please contact customer service at Racepak LLC. 949-709-5555



Installation of this product may void factory warranty as dealer may wish to verify mileage/codes/service hours etc. on factory gauge. Install at your own risk. Factory gauge may be retained and connected for use as a diagnostic tool.

Disclaimer	2
Warranty.....	2
Manual Summary.....	5
Manual Quick View.....	5
Items Included with the IQ3 Street Dash Display Kit.....	5
IQ3 Street Dash Features	6
General Feature Overview.....	6
IQ3 Street Dash Displayed Features	7
Technical Specifications.....	8
IQ3 Street Dash Functions	9
PC Minimum Requirements	9
DataLink Programming Software.....	9
IQ3 Street Dash Configuration File (software).....	9
Hardware Features	10
External Dimensions	10
External Features – Front	10
External Features – Rear.....	11
Mounting Dimensions	11
Installation	13
General Mounting Requirements.....	13
IQ3 Street Dash Wiring Pinout	14
External V-Net Sensor Connection (optional add ons).....	17
Factory Default Display Settings.....	19
External Programming Buttons	21
Button Programming Modes	21
General Button Operation	21
Button Functions in Normal Display	22
Button Functions in Setup Mode.....	22
Programming in Setup Mode	22
Oil Pressure, Water and Transmission Temperature Sensor Installation:.....	28
Fuel Level.....	29
Speedometer Sensor Interface.....	31
Display Clock/Time:	32
OBDII and EFI Interface:	33
DatalinkII Software Installation	35
Configuration Files	36
Stand Alone or with V-Net Sensors, No External Data Recorder.....	36

IQ3 Street Dash with Data Recorder 37

Programming the Display Using the DataLink Software39

 Com Port Settings 39

 Reading/Syncing of the Configuration File 40

 EFI Interface Programming 41

 Programming the Display Pages 43

 Programming the Warnings..... 45

Troubleshooting and FAQ49

 DataLink will not communicate with the IQ3 Street Dash when using the USB programming cable..... 49

 V-Net Sensor Channels “lock up” from time to time 49

Conclusion50

Manual Summary

This manual makes the assumption that you have installed the most current version of the DataLink PC software and IQ3 firmware. IQ3 Street Dash firmware and DataLink updates can be found at <http://www.racepak.com/downloads>. As of this writing, the most current DataLink version is 4.6.0 and the most current IQ3 Street Dash firmware version is 2.5.

Manual Quick View

The following provides a quick view of the manual layout:

1. IQ3 Street Dash Features
 - a. Dash
 - b. Available channels for display
 - c. External optional sensors
 - d. Technical specifications
2. Installation
 - a. Dash
 - b. Software
3. Programming The Display
4. Adding Sensors
5. Software Usage

Items Included with the IQ3 Street Dash Display Kit

Qty.	Part Number	Description
1	250-DS-IQ3S	IQ3 Street Dash Display Kit (incls. all below items)
1	280-CA-IQ3S	Harness/Street Dash Interface
1	280-CA-VM-TCAPM	V-Net Male Terminator Cap
1	890-CA-USBABM-6	USB Programming/Communication Cable
1	810-PT-0100SD	Sensor, analog pressure 0-100 psi
2	810-TR-250	Sensor, analog single wire temperature 0-250°F
1	890-DR-USB-1GB	DataLink Software Memory Stick
2	800-SW-PSHBTN	Momentary Style Push Buttons, spade terminal
1	N/A	Installation Manual

IQ3 Street Dash Features

The IQ3 Street Dash is a fully programmable LCD digital display dash that displays information to the user. It does not have a built-in data logger or accelerometers. It can be used as a standalone unit or with any Racepak V-Net capable data logger, such as the G2X, G2XPro and V300SD. All segments will light up for 1 second at power up.

General Feature Overview

28 Programmable Items on 4 pages
Internal Progressive Shift Light LEDs
4 User Programmable Internal Warning Light LEDs with On-Screen Text Warning
5 Character Programmable Alpha/Numeric Text per Display Channel
Rear Mounted Power/Ground/Street Dash Adapter/Programming Buttons Input
Rear Mounted V-Net Sensor Connector
Polarized and Shielded, Anti-Glare Coated Display For Sunlight Viewing
Metric and English (SAE) Capable
Dimmable Blue Backlight
Gear Position Indicator
Clock / Time Keeper
2 Remote Switch Inputs (Toggle Pages, Acknowledge Warnings, Basic Setup Parameters)
External Shift Light Output (750mA Max Ground Triggered)
External Warning Light Output (750mA Max Ground Triggered)
Cooling Fan Output to Trigger Fan Relay (Relay required, 750mA Max Ground Triggered)
CAN bus for OBDII or 3 rd Party ECU's Interface
16 Additional Sensor Inputs via V-Net (CAN bus)
USB Port for DataLink Communication
Compatible with Racepak Data Loggers

IQ3 Street Dash Displayed Features

Using the supplied components in the kit, data from the factory engine control unit (via the main harness connection) can be acquired for display purposes on the IQ3 Street Dash. Below is a list of that information that is available to the end user.

Engine RPM
Speedometer
Engine Coolant Temperature
Oil Pressure
Oil Temperature
Transmission Temperature
Fuel Level
Left/Right Turn Signal Indicator
Parking Brake Indicator
High Beam Indicator
Internal Progressive Shift Light LEDs
4 Internal Warning Light LEDs
Clock / Time Keeper
Gear Position (indicates gear position, center display position only)
Battery Voltage (Internal)

Technical Specifications

Total Sensor Channels - Defined Below	28
Available V-Net Data Channels (optional additions)	16
Internal Channels as Defined Below	1
IQ3 Internal Channel	Voltage
Processor Speed	20MHz
Power & Current	
Input Voltage	9-18V
Current Draw	350mA - Without warning and shift LED's active
Reverse Voltage Protection	Yes
Operating Temperature	32 - 140°F / 0-60°C
Mounting Orientation	Rear of dash facing direction of travel

IQ3 Street Dash Functions

The IQ3 Street Dash is the main component of the system, as it contains the main communication module.

PC Minimum Requirements

Windows® XP / Vista / 7 / 8 / 10 operating system
USB 2.0 Port/ 1024 x 768 or higher monitor resolution

DataLink Programming Software

The DataLink software is used to both set up and configure the IQ3 Street Dash. It will be used to modify any settings, page layouts, warning light settings, etc. The DataLink software requires a Windows based PC with a USB 2.0 port for communication. Programming cable is supplied in the kit.

IQ3 Street Dash Configuration File (software)

The Configuration File contains the programming settings for both the dash and any internal and external sensors utilized by the IQ3 Street Dash. Any additional sensors that were not shipped with the IQ3 Street Dash will require updating and syncing of the configuration file.

Terminology

In order to assist in the installation and usage of the IQ3 Street Dash, the following provides an outline of the most commonly used words that will be encountered in this manual:

Analog: Data created by the reading of a voltage change sent from a sensor.
Calibrate: The process of assigning values to sensor voltage output, in order to graph and analyze the sensor data.
CAN bus: The specific name of the technology utilized to create the V-Net sensor system.
Channel: The input from one sensor.
Digital: A sensor or signal that has only two values, off or on such as the measuring of ignition pulses to calculate Engine RPM.
HZ: Number of times per second. Used to define sample rate. Example: 4Hz represents data that is saved 4 times (every .250) per second.
Sensor: A device that converts a physical property, such as pressure into a voltage signal.
Transducer: See Sensor.
V-Net Channel: Any sensor that is connected to the V-Net port of the IQ3 Street Dash.
V-Net: Racepak exclusive that allows multiple sensors (analog or digital) to transmit their data over a single cable, back to the IQ3 Street Dash.

Hardware Features

External Dimensions

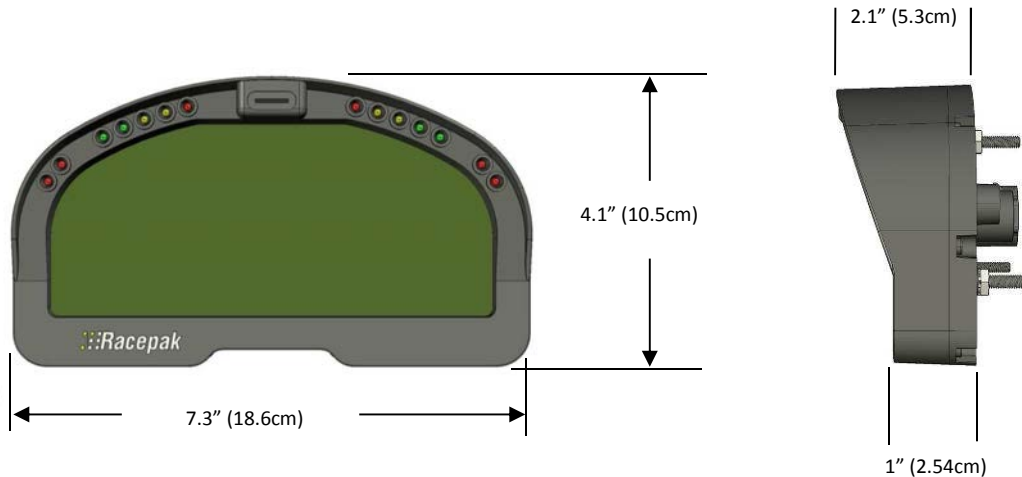

External Features - Front

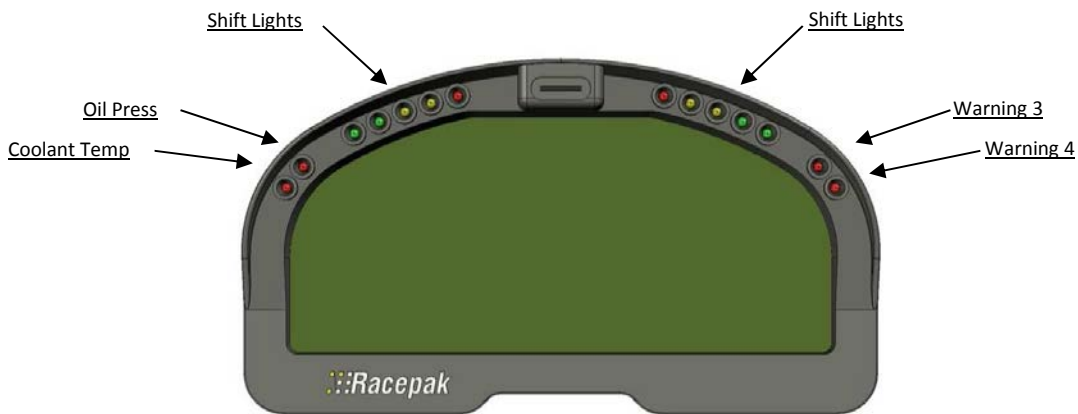

Shift Lights	Fully programmable sequential shift lights
Coolant Temp Warning	Pre-set warning lights for high engine temperature >225°F
Oil Pressure Warning	Pre-set warning light for low oil pressure <20psi
Warning Lights 3 & 4	User programmable warning lights for Inputs 3 & 4

External Features - Rear

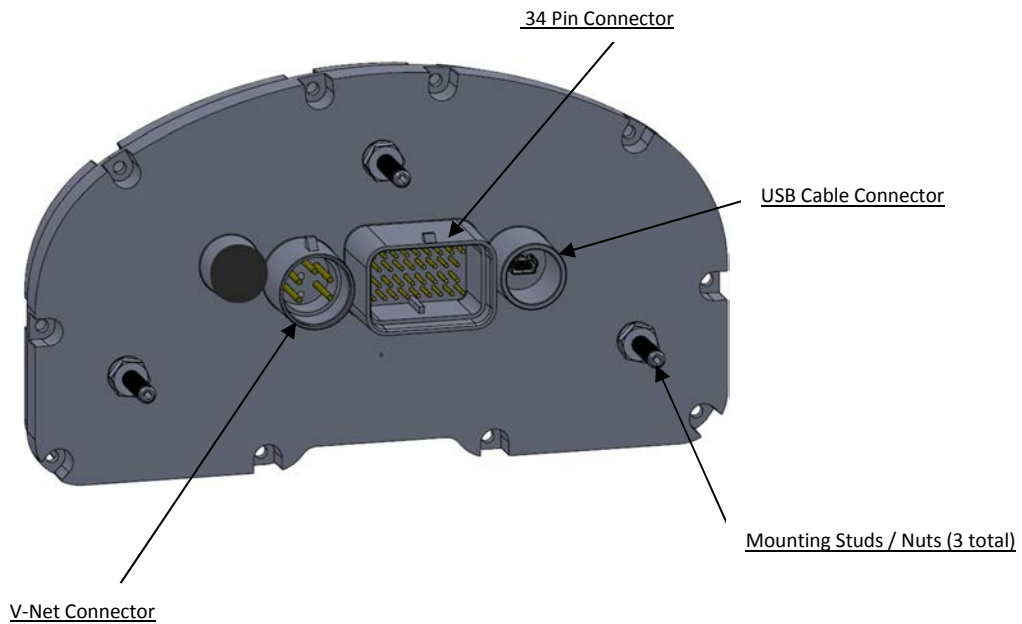

V-Net Connector	Provides input for external sensor(s) V-Net cable
Amp 34 Pin Connector	Provides input for power / ground / programming buttons
USB Cable Connector	Provides input for USB programming cable supplied with package
Mounting Studs & Nuts	Three #10 studs and 10-32 nuts facilitate mounting

Mounting Dimensions

Mounting template for printing and drilling. Verify printed dimensions on Racepak unit before drilling

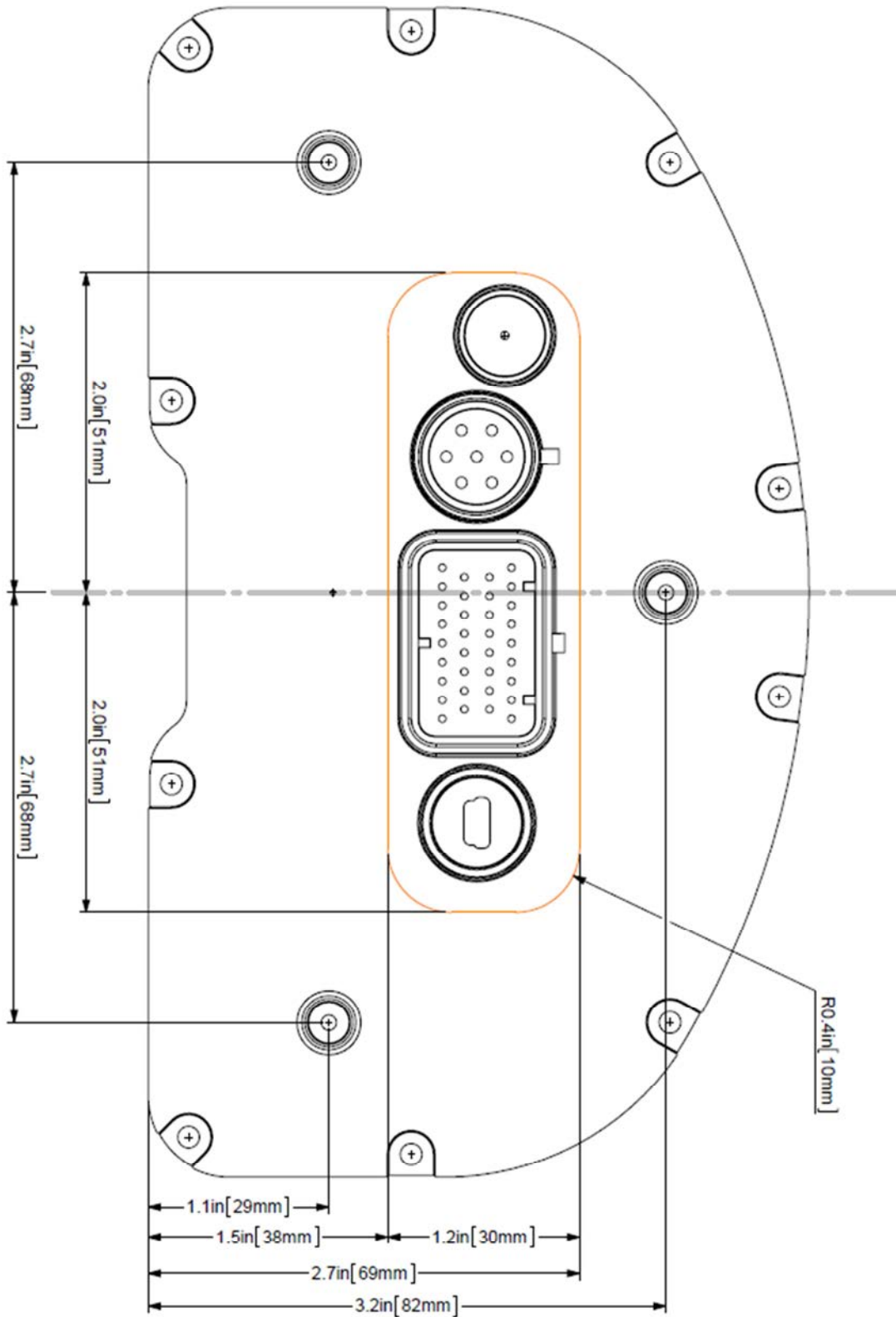

Installation

The design of the IQ3 Street Dash kit greatly simplifies the installation process, as there is no external data logger or related components necessary. However, there are basic guidelines that must be followed in order to ensure correct operation of the product.

General Mounting Requirements

The IQ3 Street Dash is designed to be utilized in a typical street car environment and is designed as such. However, there are external conditions that can influence the operation and longevity of the product and associated wiring.

Heat

Avoid excessive heat, such as generated from exhaust systems, transmissions, etc.

Electrical Interference

Avoid electrical interference. Vehicles generate electrical interference from a variety of locations such as ignitions, alternators, ECU, spark plugs, coils and radio/GPS/telemetry antennas. This interference can affect the signals generated by any or all of the sensors that relay information back to the dash.

Moisture

Avoid excessive moisture. The IQ3 Street Dash is designed to be water resistant but not waterproof. This means when installed in open cockpit type of vehicles (such as, convertibles) it is safe for use in light rain but not designed to be subject to immersion of water. Excessive water buildup can enter dash and damage the unit.

Cleaning

Clean glass lens initially with a lint-free, non-abrasive (microfiber type) cloth. Do not apply too much pressure to the screen. If using a cleaning solution, **DO NOT** use an all-purpose cleaner with acetone, ammonia-based or alcohol, since they can take off the dash's protective coating. 100% distilled water and/or 50%/50% distilled water and white vinegar is best. Heavy dust and dirt can be blown away by using small cans of compressed air made for cleaning camera and computer equipment.

Mounting Orientation of IQ3 Street Dash

It is important to insure the IQ3 cannot become dislodged during use. Three #10 studs are provided in order to provide secure mounting. If desired, the studs can be unscrewed from the threaded inserts located in the dash housing.

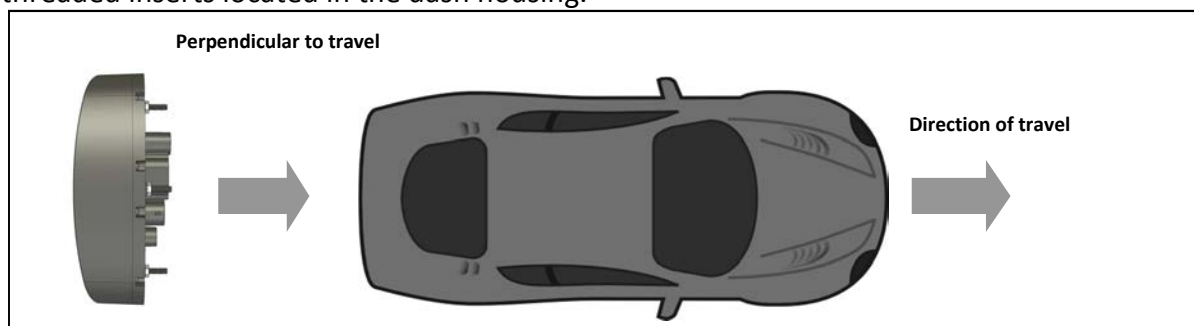

IQ3 Street Dash Wiring Pinout

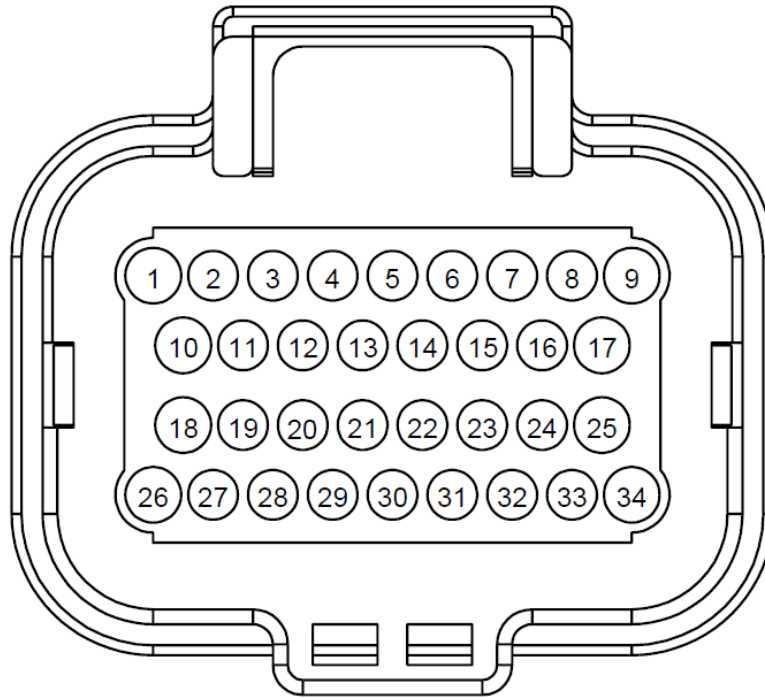

REAR VIEW OF CONNECTOR

Connector Pinout

Pin Position	Description	Color	Function / Wiring
1	Battery Positive	Red	Connect this input to a fused power source that is hot only when the ignition switch is on. We recommend using a 3 to 5 amp fuse when making this power connection. The safe operating voltage range is 9 – 18 volts DC.
2	Left Turn	Blue/White	Connect to the left turn signal circuit on the vehicle. Applying power to this input will cause the turn signal indicator on the dash to turn on.
3	Right Turn	Green/White	Connect to the right turn signal circuit on the vehicle. Applying power to this input will cause the right signal indicator on the dash to turn on.

4	Parking Brake	White	Connect to the parking brake switch on the vehicle. Grounding this input will cause the parking brake indicator on the dash to turn on
5	High Beam	Brown	Connect to the high beam circuit on the vehicle. Applying power to this input will cause the high beam indicator to turn on.
6	Tail Lights (Dim lighting)	Light Green	Connect to the head or tail light signal circuit on the vehicle. Applying power to this input will cause the IQ3 to go into night mode (dimmed settings for all lights will be used).
7	Not Used	N/A	
8	External Shift Light	Orange/White	Optional, if an external remote shift light is desired. Connect to the negative side of the shift light. Apply a fused 12 volt power source that is hot only when the ignition switch is on to other terminal on shift light. This output applies ground to the circuit when shift point values are met. 750mA ground sink maximum
9	Tachometer	Yellow	Connect this input to the tach output signal from your ignition box. The tachometer input requires a standard 5 – 20 volt, 50% duty cycled square wave signal to work properly. DO NOT CONNECT THIS WIRE DIRECTLY TO THE IGNITION COIL. DOING SO CAN DAMAGE THE CIRCUIT.
10	Not Used	N/A	
11	Sensor 5v output (not used)	N/A	Not used for factory supplied sensors. Optional, available to supply regulated 5 volts out for aftermarket sensors. Short circuit protected, 50mA max (shared between all Sensor 5v outputs)
12	Sensor ground (not used)	N/A	Not used for factory supplied sensors. Optional, available to supply ground for aftermarket sensors.
13	Oil Pressure	Tan	Connect to the supplied oil pressure sensor using the supplied #10 ring terminal.
14	Sensor 5v output (not used)	N/A	Not used for factory supplied sensors. Optional, available to supply regulated 5 volts out for aftermarket sensors. Short circuit protected, 50mA max (shared between all Sensor 5v outputs)

15	Sensor ground (not used)	N/A	Not used for factory supplied sensors. Optional, available to supply ground for aftermarket sensors.
16	Oil Temperature	Green	Connect to the supplied oil temperature sensor using the supplied #10 ring terminal.
17	CAN High	Yellow	CAN High for ECU connections if applicable
18	Cooling Fan	Violet/White	RELAY REQUIRED (Do Not Connect to Fan Directly) Optional, if a cooling fan control is desired. Connect to the negative side of cooling fan relay; typically pin 86 on a standard automotive relay. This output controls ground to the circuit when cooling fan on/off value is met. 750mA ground sink maximum See the Cooling Fan Wiring Diagram below
19	Sensor 5v output (not used)	N/A	Not used for factory supplied sensors. Optional, available to supply regulated 5 volts out for aftermarket sensors. Short circuit protected, 50mA max (shared between all Sensor 5v outputs)
20	Sensor ground (not used)	N/A	Not used for factory supplied sensors. Optional, available to supply ground for aftermarket sensors.
21	Fuel Level	Blue	Connect to the fuel sender output signal.
22	Sensor 5v output (not used)	N/A	Not used for factory supplied sensors. Optional, available to supply regulated 5 volts out for aftermarket sensors. Short circuit protected, 50mA max (shared between all Sensor 5v outputs)
23	Sensor ground (not used)	N/A	Not used for factory supplied sensors. Optional, available to supply ground for aftermarket sensors.
24	Coolant Temp	Gray	Connect to the supplied water temperature sensor using the supplied #10 ring terminal.
25	CAN Low	Green	CAN Low for ECU connections if applicable
26	Battery Ground	Black	Connect this input to a battery ground
27	Ground (not used)	N/A	Not used for factory supplied sensors. Optional, available to supply ground for aftermarket sensors.
28	Ground (not used)	N/A	Not used for factory supplied sensors. Optional, available to supply ground for aftermarket sensors.

29	Remote Switch 2	Gray/White	Connect to a normally open momentary pushbutton. Momentarily grounding this input will activate button 2 circuit. See button functions later in this manual for complete description of all button functions
30	Remote Switch 1	Brown/White	Connect to a normally open momentary pushbutton. Momentarily grounding this input will activate button 1 circuit. See button functions later in this manual for complete description of all button functions
31	Sensor 12v output (not used)	N/A	Optional, if utilizing aftermarket Hall Effect sensors for speed input. Available to supply regulated 12 volts out for aftermarket sensor Short circuit protected, 50mA max
32	Speedometer	Violet	Connect to the output of your speedometer sender. See the Speedometer Sender Interface section for instructions on interfacing with your speedometer sender
33	Sensor ground (not used)	N/A	Optional, if utilizing aftermarket Hall Effect sensors for speed input. Available to supply ground for aftermarket sensor
34	External Warning Light	Orange/Yellow	Optional, if an external remote warning light is desired. Connect to the negative side of the remote warning light. Apply a fused 12 volt power source that is hot only when the ignition switch is on to other terminal on warning light. This output applies ground to the circuit when warning parameter values are met. 750mA ground sink maximum

External Programming Button and Fan output Wiring Diagram

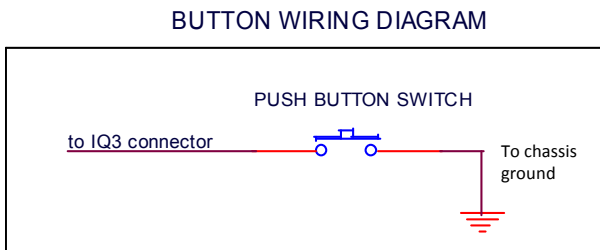

EXTERNAL FAN OUTPUT WIRING DIAGRAM

Optional – Not required for normal dash operation

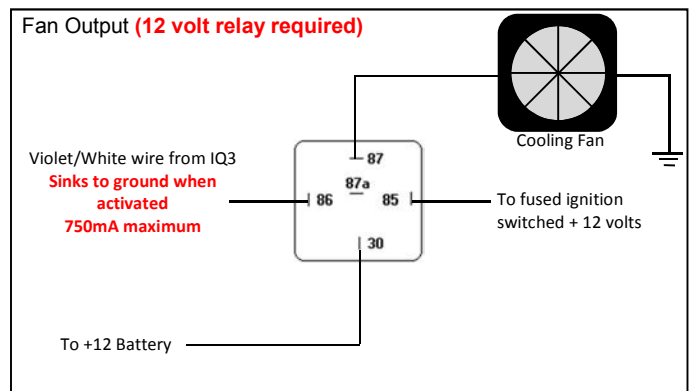

External V-Net Sensor Connection (optional add ons)

When installing any optional additional sensors to the IQ3 Street Dash, it will utilize the Racepak V-Net (CAN bus) for input. These added sensors are connected using “stackable” modules that connect to the round 5 pin V-Net port on the rear of the dash. This design provides the ability to transmit all sensor data through a single cable by use of these “stacking” modules. A cap is then placed at the end of the “stack” to terminate the system. The modules are typically available with sensors in kit form. Extension cables are available in a variety of lengths to connect multiple “stacks” of modules that may be installed in different locations throughout the vehicle.

To add sensors, the customer simply measures from the IQ3 Street Dash to the mounting location of the “stackable” module or modules, and orders the appropriate length pre-terminated V-Net extension cable. V-Net cables are available in 12” increments and are equipped with a male connector on one end and a female connector on the opposite end. In the event sensors are mounted in multiple locations throughout the vehicle, simply measure between each sensor location and order the necessary V-Net extension cables to connect all items to the main V-Net cable routed to the rear of the dash.

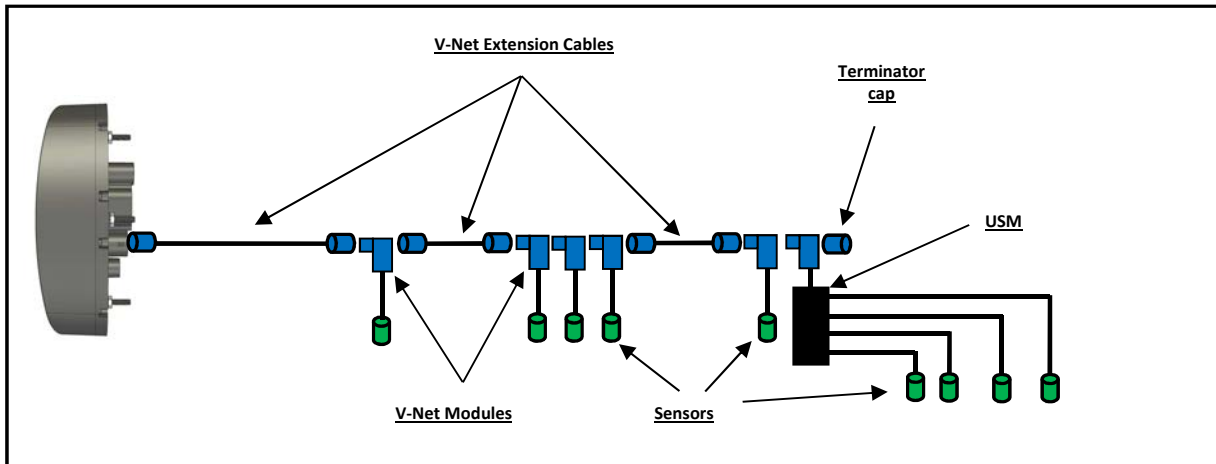
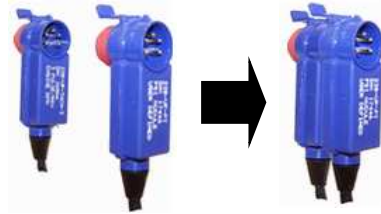

Any V-Net sensor currently offered by Racepak may be utilized by the IQ3 Street Dash. For a complete listing of available sensors, visit our website located at www.racepak.com or contact the Racepak customer service department at 949-709-5555 for a catalog. Customer supplied sensors may also be utilized. Racepak USM module (PN: 230-VM-USM) is a four sensor input module, providing the ability to define each sensor input dependent on the sensor type. DataLink software is used to both set up and configure the IQ3 Street Dash using a Windows based PC. It will be used to modify any settings, page layouts, warning light settings, add additional sensors, etc. See Programming the *Display Using the DataLink Software* section shown later in this manual for further details.

Factory Default Display Settings

The Racepak IQ3 Street Dash is shipped with factory pre-programmed display pages. To modify these display pages, you must use a PC, programming cables and the Datalink program. This is outlined in the *Programming the Display Using the DataLink Software* area of this manual. Using the external programming buttons, a factory reset can be performed to revert all settings and pages back to as factory shipped (excludes hour/service and odometer values). Further details about the display page settings can be located later in this manual in the *Programming the display* section found on [page 43](#).

From the factory, Page 1 of the IQ3 Street Dash is programmed to display the following items.

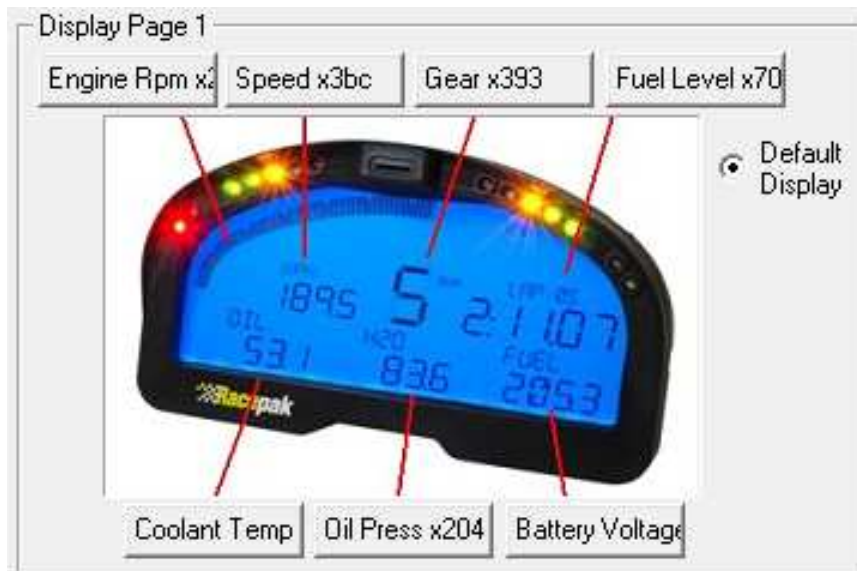

From the factory, Page 2 of the IQ3 Street Dash is programmed to display the following items.

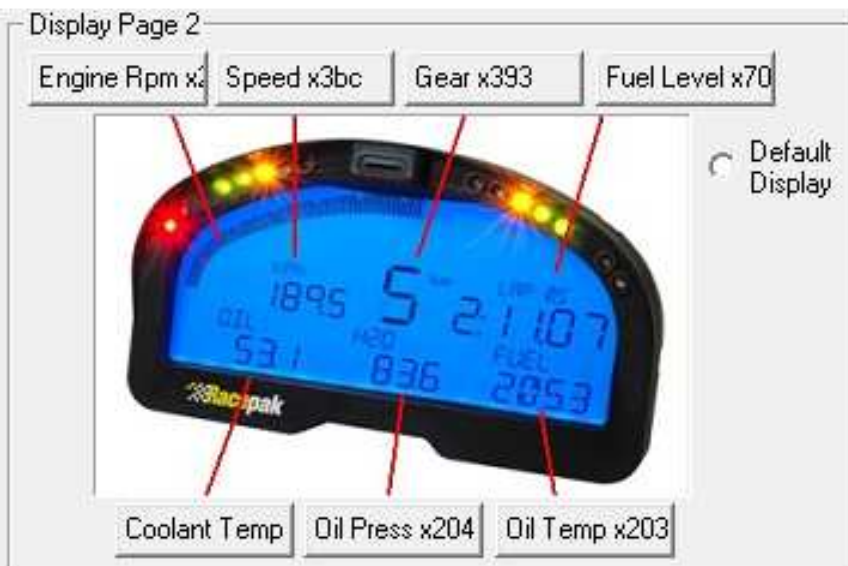

From the factory, Page 3 of the IQ3 Street Dash is programmed to display the following items



From the factory, Page 4 of the IQ3 Street Dash is programmed to display the following items

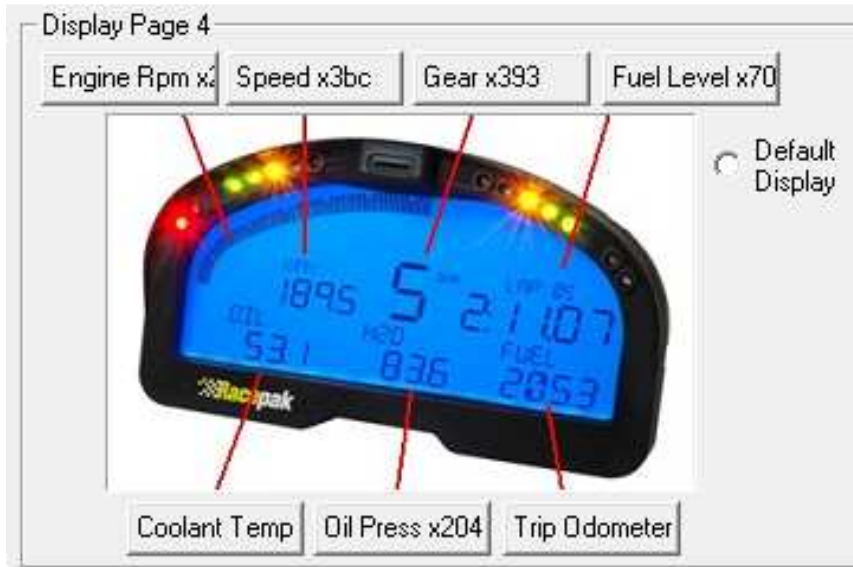

External Programming Buttons

A variety of IQ3 Street Dash display functions can be controlled, displayed or programmed through use of two external programming buttons known as Button 1 and Button 2. This enables the driver to make immediate changes without the necessity of connecting a PC to the dash. Instead of mounting the programming buttons directly in the dash, Racepak provides the ability to remote mount the two programming buttons for better driver access.

Racepak supplies (2) two buttons with the IQ3 Street Dash however, the customer may utilize their own preference of momentary contact button type. The customer must ensure, the buttons selected, are normal open momentary switches and that they are capable of withstanding the environment in which they will be utilized. The buttons are connected to the 34 pin AMP connector located on the rear of the IQ3 Street Dash. Refer to the IQ3 Street Dash Wiring Pinout section, for pin out instructions.

Many of the programming functions found in the following section may also be performed through the use of the DataLink software and the user's PC. These instructions can be found in the section [Programming Utilizing the DataLink Software](#) section.

Button Programming Modes

Setup Mode 1 (Stationary): Utilized to program items such as screen brightness or pulses per revolution (tach programming).

Setup Mode 2 (Moving): Utilized to program the system while the vehicle is moving and or the engine is running. This is necessary as several settings utilize actual data taken from speed or rpm, in order to program.

General Button Operation (Display and Setup)

Basic programming functions of the IQ3 Street Dash are accessed by using Button 1 and Button 2. It is recommended the two programming buttons be mounted as Left and Right in relation to the driver's position viewing the dash. There are two programming modes available referenced as Normal Display and Setup Mode.

Since the IQ3 Street Dash only utilizes two buttons, it is necessary to allow multiple uses for each button. In each of the modes, the length of time each button is held down, before releasing, determines the exact result. The following instructions will refer to short, medium and long button press lengths. This is the length of time the button is held down and the corresponding warning light blink. The point at which the button is released determines the type press that is accepted. As an example, releasing after the second LED warning light flash is detected as a medium length press.

Type of Button Press	Length of Time	Warning Light Flash
Short Press and Release	.2 Second before release	One Flash Of Shift Lights
Medium Press and Release	.5 Second before release	Two Flashes Of Shift Lights
Long Press and Release	2 Seconds before release	Three Flashes Of Shift Lights

Button Functions in Normal Display (Stationary) mode

While the IQ3 Street Dash is in normal display mode, the programming buttons will perform the following functions:

Button	Short Press (1 flash)	Medium Press (2 flashes)	Long Press (3 flashes)
Button 1	Advance to Next Display Page	Enter Setup Mode 1	Displays the current time in upper right display position
Button 2	Clear/Acknowledge any Active Warnings	Enter Setup Mode 2	Does nothing

Button Functions in Setup Mode

While the IQ3 Street Dash is in setup mode, the programming buttons will perform the following functions:

Button	Short Press (1 flash)	Medium Press (2 flashes)	Long Press (3 flashes)
Button 1	Advances to Next Available Parameter	Accepts change and advances to next available parameter.	Saves Changes and Exits
Button 2	Changes Parameter Value (see below programming chart for each parameter)	Changes Parameter Value (see below programming chart for each parameter)	Changes Parameter Value (see below programming chart for each parameter)

Programming in Setup Mode

The programming functions are arranged in a pre-defined order. This allows the user to enter the programming mode, and then toggle through to the desired feature by using the left or right button, depending on the mode.



Setup Mode is used to program the unit without the need to connect to a PC. It is utilized to program items such as screen brightness, LED brightness, reset to defaults, etc.



Entering Setup 1

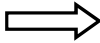

1. Press and hold the Button 1 for TWO shift light blinks – MEDIUM press
2. The Dash will display **SETUP 1?**
3. Confirm you wish to enter the setup mode by pressing the Button 1 for ONE shift light blink – SHORT press



To cancel entering Setup Mode 1, press the Button 2 for a SHORT press

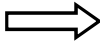

The following are in the order in which the individual programming features will appear.

Setting as Displayed on Dash	Program Setting Description	Programming Command *****	Accept and Advance 	Accept and Exit 
RESET TRIP ODO	Resets odometer setting to zero N = No Y = Yes	Short Press Button 2 to toggle between Y/N	Short Press Button 1	Long Press Button 1

Setting as Displayed on Dash	Program Setting Description	Programming Command *****	Accept and Advance 	Accept and Exit 
SET DEFAULTS	Resets all dash settings to factory default values N = No Y = Yes Auto saves and exits when selected- All settings and pages are set back to as factory shipped, except for hour/service and odometer values	Short Press Button 2 to toggle between Y/N	Short Press Button 1	Long Press Button 1
SET TIME/DATE	Adjust time of clock feature N = No Y = Yes If Yes is selected and accepted, Button 2 increases time Button 1 accepts value, moves to minutes, AM/PM etc	Short Press Button 2 to toggle between Y/N	Short Press Button 1	Long Press Button 1
BACKLIGHT	Backlight Brightness 0 = Off 10 = Maximum Brightness Factory Default is 7	Short Press Button 2 to increase value	Short Press Button 1	Long Press Button 1
DIM BACKLIGHT	Dim Backlight Brightness 0 = Off 10 = Maximum Brightness Factory Default is 3 Dim refers to state when pin 6 has power applied to it.	Short Press Button 2 to increase value	Short Press Button 1	Long Press Button 1
LED BRITE	Onboard shift/warning LED Brightness: 1 = Minimum Brightness 10 = Maximum Brightness Factory Default is 7	Short Press Button 2 to increase value	Short Press Button 1	Long Press Button 1
DIM LED BRITE	Onboard shift/warning Dim LED Brightness: 1 = Minimum Brightness 10 = Maximum Brightness Factory Default is 3	Short Press Button 2 to increase value	Short Press Button 1	Long Press Button 1
EXT WARN BRITE	External Warning Light Brightness: 1 = Minimum Brightness 10 = Maximum Brightness Factory Default is 7	Short Press Button 2 to increase value	Short Press Button 1	Long Press Button 1
EXT DIM WARN BRITE	External Warning Light Dim Brightness: 1 = Minimum Brightness 10 = Maximum Brightness Factory Default is 3	Short Press Button 2 to increase value	Short Press Button 1	Long Press Button 1

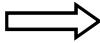

Setting as Displayed on Dash	Program Setting Description	Programming Command *****	Accept and Advance 	Accept and Exit 
EXT SHIFT BRIGHT	External shift light Brightness: 1 = Minimum Brightness 10 = Maximum Brightness Factory Default is 10	Short Press Button 2 to increase value	Short Press Button 1	Long Press Button 1
EXT DIM SHIFT BRITE	External shift light Dim Brightness: 1 = Minimum Brightness 10 = Maximum Brightness Factory Default is 3	Short Press Button 2 to increase value	Short Press Button 1	Long Press Button 1
SHIFT GEAR X (X = Gear number)	Program shift point for each gear. Factory Default is: Shift 1 7000 Shift 2 7000 Shift 3 7000 Shift 4 7000 Shift 5 7000 Shift 6 7000	Short Press Button 2 increases value by 10 Medium Press Button 2 Decreases by 500	Short Press Button 1 advances to next gear	Long Press Button 1
DEFAULT DISPLAY	Default page on power up. If all positions are disabled, that page will not be displayed. 1 = Min 4 = Max Factory Default is 1	Short Press Button 2 Advances to next Display Page	Short Press Button 1	Long Press Button 1
TACH PULSES	Number of pulses ignition fires per revolution V8 = 4 4 Cyl = 2 0 = Minimum 16 = Maximum Factory Default is 4	Short Press Button 2 Increases by 1 Medium Press Button 2 Decreases by 1	Short Press Button 1	Long Press Button 1
TACH ODDFIRE	Number of pulses ignition fires for odd fire applications 0 = Minimum 16 = Maximum Factory Default is 0	Short Press Button 2 Increases by 1 Medium Press Button 2 Decreases by 1	Short Press Button 1	Long Press Button 1
SENS - SPEED	Type of Speed Sensor Factory Default is 2-Wire VR	Short Press Button 2 changes type of sensor	Short Press Button 1	Long Press Button 1

Setting as Displayed on Dash	Program Setting Description	Programming Command *****	Accept and Advance 	Accept and Exit 
SENS - OIL P	Type of Oil Pressure Sensor Factory Default is 2-Wire 100 PSI	Short Press Button 2 changes type of sensor	Short Press Button 1	Long Press Button 1
SENS - ECT	Type of Coolant Temperature Sensor Factory Default is 1-Wire RP Deg F	Short Press Button 2 changes type of sensor	Short Press Button 1	Long Press Button 1
SENS - OIL T	Type of Oil Temperature Sensor Factory Default is 1-Wire RP Deg F	Short Press Button 2 changes type of sensor	Short Press Button 1	Long Press Button 1
SENS - FUEL	Type of Fuel Sensor Factory Default is 240-33 Ohms (E-F) See Fuel Level Section for custom calibrations	Short Press Button 2 changes type of sensor	Short Press Button 1	Long Press Button 1
ODOMETER	Odometer value, sets starting odometer value. Odometer increments with mileage.	Short Press Button 2 Increases by 10 Medium Press Button 2 Decreases by 1000	Short Press Button 1	Long Press Button 1
TYPE - ECU	Type of Engine Control Unit Factory Default is Disabled	Short Press Button 2 changes the type of engine control unit	Short Press Button 1	Long Press Button 1
WARN - COOLANT TEMP	High Water temp warning value Value to be used for control of High H2O temp Light (Lower Left LED) Factory Default is 220	Short Press Button 2 Increases by 1 Medium Press Button 2 Decreases by 10	Short Press Button 1	Long Press Button 1

Setting as Displayed on Dash	Program Setting Description	Programming Command *****	Accept and Advance 	Accept and Exit 
WARN - OIL PRESS	Low oil pressure warning value Value to be used for control of Low oil pressure Light Factory Default is 20	Short Press Button 2 Increases by 1 Medium Press Button 2 Decreases by 10	Short Press Button 1	Long Press Button 1
FAN ON TEMP	Fan On Output value Value to be used for control for fan output Factory Default is 180	Short Press Button 2 Increases by 1 Medium Press Button 2 Decreases by 10	Short Press Button 1	Long Press Button 1
FAN OFF TEMP	Fan Off Output value Value to be used for control for fan output Factory Default is 175	Short Press Button 2 Increases by 1 Medium Press Button 2 Decreases by 10	Short Press Button 1	Long Press Button 1

Entering Setup 2

1. Press and hold Button 2 for TWO shift light blinks – MEDIUM press
2. The Dash will display **SETUP 2?**
3. Confirm by pressing Button 1 for ONE shift light blink – SHORT press
To cancel entering Setup Mode 2, press Button 2 for SHORT press

Setting as Displayed on Dash	Program Setting Description	Programming Command *****	Accept and Advance 	Accept and Exit 
CALIBRATE SPEED	Calibrates dash speed settings N = No Y = Yes See Speedometer Calibration section for detailed instructions	Short Press Button 2 to toggle between Y/N	Short Press Button 1	Long Press Button 1
CALIBRATE GEARS	Calibrates Gear Position Indicator for each gear. Manual transmissions only N = No Y = Yes See Gear Position Indicator Calibration section for detailed instructions	Short Press Button 2 to toggles between Y/N	Short Press Button 1	Short Press Button 1

Oil Pressure, Water and Transmission Temperature Sensor Installation:

The water and oil sensors provided use 1/8" NPT thread. An adaptor may be required to accommodate larger thread sizes. Make sure to use thread sealer when installing the sensors to prevent water and oil leaks. **DO NOT** use excessive amount of thread sealer on factory supplied temperature sensor since the sensor must ground via threads for proper operation. Ensure that temperature sensors are threaded into item that is grounded to the chassis.

Oil Pressure Sensor Settings

The dash is pre-configured at the factory to use a supplied two-wire 100 psi sender for oil pressure on Pin#13, Tan wire. The option to use other sensors instead of the supplied two-wire pressure sensor is available as well as using this input for other parameters beside oil pressure. When using powered sensors, extra terminals are available on rear connector of dash for 5 volt power and ground.

# Wires	ONSCREEN NAME	RANGE	NOTES & SCALING
2	100 PSI	0 - 100 psi	Racepak #810-PT-0100SD Ω style with 499 Ohm pull-up
3	150 PSI	0 - 150 psi	Racepak #810-PT-0150GVT 5v powered, .5v=0 4.5v=150
3	300 PSI	0 - 300 psi	Racepak #810-PT-0300GVT 5v powered, .5v=0 4.5v=300
3	500 PSI	0 - 500 psi	Racepak #810-PT-0500GVT 5v powered, .5v=0 4.5v=500
3	1500 PSI	0 - 1500 psi	Racepak #810-PT-1500HP 5v powered, .5v=0 4.5v=1500
3	3000 PSI	0 - 3000 psi	Racepak #810-PT-3000HP 5v powered, .5v=0 4.5v=3000
3	Vacuum - KPA	0 - 30 Vac kPa	Racepak #810-PT-VB 5v powered, 1.8v=0 .5v=105
3	15 PSI - KPA	0 - 103 kPa	Racepak #810-PT-0015GVT 5v powered, .5v=0 4.5v=103.42
3	75 PSI - KPA	0 - 517 kPa	Racepak #810-PT-0075GVT 5v powered, .5v=0 4.5v=517.1
2	100 PSI - KPA	0 - 690 kPa	Racepak #810-PT-0100SD Ω style with 499 Ohm pull-up
3	150 PSI - KPA	0 - 1034 kPa	Racepak #810-PT-0150GVT 5v powered, .5v=0 4.5v=1034.2
3	300 PSI - KPA	0 - 2068 kPa	Racepak #810-PT-0300GVT 5v powered, .5v=0 4.5v=2068.4
3	500 PSI - KPA	0 - 3447 kPa	Racepak #810-PT-0500GVT 5v powered, .5v=0 4.5v=3447
3	1500 PSI - KPA	0 - 10342 kPa	Racepak #810-PT-1500HP 5v powered, .5v=0 4.5v=10342
3	3000 PSI - KPA	0 - 20684 kPa	Racepak #810-PT-3000HP 5v powered, .5v=0 4.5v=20684
	User Cal		Custom user scale
	Disabled		Disabled, input is not used and will not stream/record data
	0-5 volts		0-5 volt input, must use software to program, Raw Data A, Raw Data B, Min, Max Result Values
3	VACUUM	0-30 inHg	Racepak #810-PT-VB 5v powered, 1.8v=0 .5v=29
3	15 PSI	0 – 15 psi	Racepak #810-PT-0015GVT 5v powered, .5v=0 4.5v=15
3	75 PSI	0 – 75 psi	Racepak #810-PT-0075GVT 5v powered, .5v=0 4.5v=75

Water Temperature Sensor Settings

The dash is pre-configured at the factory to use a supplied single-wire 0-250 °F temperature sender for Water Temperature on Pin#24, Gray wire. The option to use other sensors instead of the supplied single-wire temperature sensor is available as well as using this input for other parameters beside water temperature. When using powered sensors, extra terminals are available on rear connector of dash for 5 volt power and ground.

# Wires	ONSCREEN NAME	RANGE	NOTES & SCALING
1	RP DEG-F	0 - 250 °F	Racepak Single Wire #800-TR-250 Ω style with 499 Ohm pull-up
2	RP DEG-F	0 - 300 °F	Racepak Two Wire #800-TR-300 Ω style with 4.42K Ohm pull-up
2	GM DEG-F	0 - 300 °F	GM/Delphi Two Wire #12146312 Ω style with 499 Ohm pull-up
1	RP DEG-C	-18 - 121 °C	Racepak Single Wire #800-TR-250 Ω style with 499 Ohm pull-up
2	RP DEG-C	-18 - 149 °C	Racepak Two Wire #800-TR-300 Ω style with 4.42K Ohm pull-up
2	GM DEG-C	-18 - 149 °C	GM/Delphi Two Wire #12146312 Ω style with 499 Ohm pull-up
	User Cal		Custom user scale
	Disabled		Disabled, input is not used and will not stream/record data
	0-5 volts		0-5 volt input, must use software to program, Raw Data A, Raw Data B, Min, Max Result Values

Oil Temperature Sensor Settings

The dash is pre-configured at the factory to use a supplied single-wire 0-250°F temperature sender for Oil Temperature on Pin#16, Green wire. The option to use other sensors instead of the supplied single-wire temperature sensor is available as well as using this input for other parameters beside oil temperature. When using powered sensors, extra terminals are available on rear connector of dash for 5 volt power and ground.

# Wires	ONSCREEN NAME	RANGE	NOTES & SCALING
1	RP DEG-F	0 - 250 °F	Racepak Single Wire #800-TR-250 Ω style with 499 Ohm pull-up
2	RP DEG-F	0 - 300 °F	Racepak Two Wire #800-TR-300 Ω style with 4.42K Ohm pull-up
2	GM DEG-F	0 - 300 °F	GM/Delphi Two Wire #12146312 Ω style with 499 Ohm pull-up
1	RP DEG-C	-18 - 121 °C	Racepak Single Wire #800-TR-250 Ω style with 499 Ohm pull-up
2	RP DEG-C	-18 - 149 °C	Racepak Two Wire #800-TR-300 Ω style with 4.42K Ohm pull-up
2	GM DEG-C	-18 - 149 °C	GM/Delphi Two Wire #12146312 Ω style with 499 Ohm pull-up
	User Cal		Custom user scale
	Disabled		Disabled, input is not used and will not stream/record data
	0-5 volts		0-5 volt input, must use software to program, Raw Data A, Raw Data B, Min, Max Result Values

Fuel Level

The table below shows the (8) eight different types of fuel senders supported. If you are not sure of the type you are using you will have to measure the resistance with an ohms meter or for best accuracy use the custom setting. See Setup Mode below.

ONSCREEN NAME	Resistance Empty - Full	Typical Application
240 - 33 OHM	240 - 33 Ohms	Stewart Warner senders
90 - 0 OHM	90 - 0 Ohms	Toyota, Nissan
73 - 10 OHM	73 - 10 Ohms	Most Ford Prior to 1986 & Chrysler
40 - 250 OHM	40 - 250 Ohms	Most General Motors 1998 to present
16 - 158 OHM	16 - 158 Ohms	Most Fords 1987 to present
10 - 180 OHM	10 - 180 Ohms	VDO senders
0 - 90 OHM	0 - 90 Ohms	Most General Motors 1965 to 1997
0 - 30 OHM	0 - 30 Ohms	Most General Motors pre -1965
User Cal		Custom user scale
0 - 5 volts		0-5 volt input, must use software to program, Raw Data A, Raw Data B, Min, Max Result Values

Custom Fuel Level Calibration Procedure:

- 1) Empty the fuel tank to the level you wish to call 0%
- 2) Turn on the dash and enter setup mode 1 by entering a **MEDIUM** press on the **button 1**
- 3) The Dash will display **SETUP 1?**, accept that you wish to enter setup 1 by once again entering a **SHORT** press on the **button 1**
- 4) Step through the setup parameters by entering a **SHORT** press on the **button 1** until you reach the **SENS FUEL** parameter in the lower left LCD position
- 5) You can then step through the available fuel sensors by entering a **SHORT** press on **button 2** to reach the **USER CAL** setting
- 6) Enter a **SHORT** press on the **button 1** to select **User Cal**, **CAL FUEL LEVEL N** will be displayed
- 7) A **SHORT** press on **button 2** will change the **N** to **Y** to initiate custom calibration
- 8) A **SHORT** press on **button 1** will accept **Y** selection
- 9) Empty Voltage will be displayed. The unit uses a internal pullup resistor to convert the resistance to voltage as shown
- 10) Enter a **SHORT** press on the **button 1** to set the tank's empty value; the dash will advance to the next step.
- 11) Full Voltage will be displayed. Fill tank to the Full position. The voltage will change accordingly. Once the tank is full and the voltage stabilizes, enter a **SHORT** press on the **button 1** to set the tank's full value.
- 12) Enter a **LONG** press on the **button 1** to save settings and exit setup mode

Speedometer Sensor Interface

The IQ3 Street Dash requires an electrical speedometer output signal from the transmission. There are two different types of speedometer sender input settings, Variable Reluctance (Zero Crossing Sine Wave) and Hall Effect. The dash is defaulted for Variable Reluctance (two wire) sensor type. If the sender you are using has a Hall Effect output you will need to change the sensor type setting in the dash. See section Setup Mode for programming instructions. The table below shows the different speed sensors supported.

# Wires	ONSCREEN NAME	SENSOR TYPE
2	VR	Variable Reluctance Zero Crossing, most factory sensors with two wires or any aftermarket Variable Reluctance
3	HALL	Hall Effect, most factory sensors with 3 wires or any aftermarket Hall Effect sensor
	Disabled	

Speedometer Calibration:

To facilitate ease of calibrating the speed settings of the IQ3 Street Dash, the initial temporary use of a standalone personal GPS unit or GPS via cell phone to show current speed is required.

The speedometer, odometer and trip odometer may not read correctly until you select the appropriate speed sensor type, connect dash to a sensor and perform a calibration.

To calibrate the speed follow the below procedure.

1. Turn on the dash and enter setup mode 2 by entering a **MEDIUM** press on the **button 2**
2. The Dash will display **SETUP 2?**
3. Confirm you wish to enter setup 2 by pressing **button 1** for **SHORT** press
4. The dash will now display **CALIBRATE SPEED N**
5. Enter a short press Button 2 to toggle **N** to **Y** to prepare for the next step, **CALIBRATE SPEED Y** will be displayed
6. Safely drive vehicle at a steady rate of 40 MPH (or 40 KPH if units are to be in metric). Once at 40, enter a Short Press on Button 1 to set speed calibration value.
7. Dash will then record the correct pulse count from the connected sensor for 40 mph/kph, and will start to display to correct speed on the LCD as well as advance to the **CALIBRATE GEAR** setting.
 - a. If the vehicle is equipped with an automatic transmission enter a short press on Button 1 to save and exit speed calibration settings.
 - b. If the vehicle is equipped with a manual transmission, you now can calibrate the gear position indicator for each gear by a short press on Button 2 to change value to Y and follow the Gear Indicator calibration instructions starting at step 5.

Gear Position Indicator Calibration (Manual Transmission only):

The speedometer, odometer and trip odometer may not read correctly until you select the appropriate speed sensor type, connect dash to a sensor and perform a calibration (*See previous section*). The gear position can also be set using a calculation and then using the Datalink software while connected to a PC. See [page 47](#) for programming via Datalink software.

To calibrate the gear follow the below procedure.

1. Turn on the dash and Enter Setup 2 mode by entering a **MEDIUM** press on **button 2**
2. The Dash will display **SETUP 2?**
3. Confirm you wish to enter SETUP 2 by entering a **SHORT** press on **button 1** The dash will now display **CALIBRATE SPEED N**
4. Enter a **SHORT** press on **button 1**. The dash will now display **CALIBRATE GEARS N**
5. Enter a **SHORT** press on **button 2** to toggle **N** to **Y**
6. Enter a **SHORT** press on **button 1**, the dash will now display **GEAR 1** and a value. This value represents the ratio between engine RPM and Speed (not final drive ratio or gear ratio).
7. Safely drive vehicle at a steady rate while in first gear
8. Once at a steady speed, enter a **SHORT** press on **button 1**. This sets the value for that gear and will advance to the next gear.
9. Repeat the process above for each remaining gear. Program any unused gears the same value as your highest gear.
10. Once all gears are programmed, the last **SHORT** press on **button 1** will save and exit.

Display Clock/Time:

Clock/Time is available for viewing anytime the IQ3 Street Dash is powered on and not in any setup modes. By default, it is displayed in the upper right area only when the button 1 is held down for a set period of time, roughly 3 seconds. Regardless of what parameter is programmed in that upper right area, the location of the clock cannot be changed.

To view clock

1. At any point, in normal viewing mode, Press and hold Button 1 for THREE light blinks – LONG press
2. As long as the button is held, the display will show the time which was set in the Setup 1 programming menu.

To set the time, see **Entering Setup 1** mode section found on [page 22](#).

OBDII and EFI Interface:

The IQ3 Street Dash has a CAN interface module built directly into the circuitry from the factory. This interface is used to convert the CAN bus data stream found in most new vehicles, as well as some popular aftermarket ECUs into CAN bus data that is compatible with the IQ3 Street Dash. Data from this interface is then available to display data from the ECU's sensory array onto the IQ3 Street Dash.

Available IQ3 Street Dash ECU settings, selectable Pre-Programmed CAN protocols:

IQ3s Supported ECU	IQ3s Supported ECU
AEM V2/EMS-4/Infinity EMS	Holley Dominator
Electromotive TECGT	Fuel Tech (200,250,300,350,500)
MoTeC CAN (Data set 3)	Link G4+ Series
MegaSquirt-III (DIY Autotune)	MSD Atomic LS
Micro Tech	MSD Atomic TBI
Pro EFI	Big Stuff 3
Generic CAN	MEFI-4B
FAST XFI	OBD2

Wire Connection:

There are two (2) wires found in the rear main connector used for the OBD II and EFI interface connections.

A two (2) pin Deutsch connector is connected to the following wires:

Main connector Pin 17 = Yellow = Can High

Main connector Pin 26 = Green = Can Low

Adapter harnesses available

Although the consumer can terminate the mating Deutsch connector and connect to their ECU, adapter harnesses are available to ease installation. Mating connector is not supplied with dash, but is supplied with below adapter harnesses.

280-CA-EFICAN - Two bare wires for direct CAN interface

280-CA-EFIHOL - Holley Adaptor - includes Holley mating connector

280-CA-EFIFUEL- Fuel Tech Adaptor - includes Fuel Tech mating connector

280-CA-EFILINK- Link Adaptor - includes Link mating connector

280-CA-EFIATBI - Atomic TBI Adaptor - includes Atomic TBI mating connector

280-CA-EFIBS3 - Big Stuff 3 Adaptor - includes Big Stuff 3 mating connector

280-CA-EFIMEFI -MEFI 4B Adaptor - includes MEFI 4B mating connector

280-CA-EFIOBDII - OBDII Adaptor - includes OBDII mating connector

See included chart for list of available channels from each ECU. List may vary slightly as interfaces are sometimes being updated with information from ECU manufacturer.

Once connections are made, the dash will have to be synced and programmed for the selected ECU. See [Programming the Display Using the DataLink Software](#) sections for instructions on programming.

Channels Displayed	Channels Displayed													
	AEM	Motec (Data Set 3)	Megaquint-III DIY Autotune	Micro Tech	PRO EFI	PAST XFI GAN	Holley EFI	Fuel Tech	Link G4+ Series	MSD Atomic LS	MSD Atomic TBI	Big Stuff 3	Electromotive TecGT	IMEFI-4B
Engine RPM	X	X	X	X	X	X	X	X	X	X	X	X	X	X
Engine Load	X	X												
Throttle Position	X	X	X	X	X	X	X	X	X	X	X	X	X	X
Air/Fuel Ratio 1	X	X	X	X	X	X	X	X	X	X	X	X	X	X
Air/Fuel Ratio 2	X	X												
Air / Fuel Correction			X			X								
Air / Fuel Average							X							
EFI Voltage	X	X				X	X		X			X		
Battery Voltage			X	X				X	X	X		X	X	
Water Temperature	X	X	X	X		X	X	X	X	X	X	X	X	X
Charge Temperature							X							
Manifold Temperature			X								X		X	X
Intake Air Temperature	X	X		X		X	X	X	X					
Oil Temperature							X							X
MAP A.B.S. Pressure													X	X
Manifold Pressure (Boost)		X	X	X	X	X	X	X	X	X	X	X	X	X
Boost Stage												X		
Turbo RPM												X		
Exhaust Gas Temperature 1	X		X											
Exhaust Gas Temperature 2	X													
Exhaust Gas Temperature 3	X													
Exhaust Gas Temperature 4	X													
Cam Angle 1								X						
Ignition Timing 1	X	X	X	X	X	X	X	X	X	X	X	X	X	X
Knock													X	X
Knock Retard			X				X		X				X	
Injector Pulse Width		X	X	X		X	X		X				X	
Main Pulse Width Bank 1		X					X							
Main Pulse Width Bank 2		X					X							
Aux Pulse Width				X										
Injector Duty Cycle		X			X	X	X		X	X	X			
Injector Duty Cycle A								X						
Injector Duty Cycle B								X						
O2 Correction						X								
Power Adder Correction						X								
Wheel Speed					X									
Speed	X	X	X	X	X	X	X		X	X		X		X
Gear Indicator	X	X		X			X		X			X		
Fuel Pressure			X				X	X	X	X	X			
Pump Pressure														X
Oil Pressure				X			X	X	X	X		X		X
Crankcase Vacuum												X		
Custom 1	X	X	X	X	X									X
Custom 2	X	X	X	X	X									X
Custom 3	X			X	X									X
Custom 4	X			X	X									X
Control Flags				X										
Idle Air Control Position							X							
Injector Timing									X					
Barometer							X		X	X				
Fuel Flow						X	X							X
Lambda 1				X				X						
Manifold Vacuum														
Air Fuel Target			X			X								X
Bottle Pressure (nitrous)					X									
Waste Duty					X									
Waste Setpoint					X									
Fuel Composition			X											
MIL Check Engine														
Miss Counter														
Fuel Consumption														
Traction Control Retard			X											
Launch Control Retard			X											
2-Step Button Status								X		X				
Fuel Pump State								X						
AC State								X						
Fan State								X						
Fan Stat 1									X	X				
Fan Stat 2									X	X				
Traction State								X						
Drag Speed								X						
Closed Loop Stat									X	X				
Rev Limit Stat									X					
TCM Gear									X					
IAC Position											X			
DTC Counts										X				
O2 Stat										X				
FP Cav Stat										X				
Nitrous Stat										X				
BML Stat										X				
Fuel Press Stat										X				

DatalinkII Software Installation

The DatalinkII software is utilized to program the IQ3 Street Dash unit. If a previous version of DatalinkII exists on the programming PC, update to the latest DatalinkII software (version 4.6.0 or higher), included with the IQ3 Street Dash package.



During the program installation (step 7), select the unit to be utilized. Be sure to select “IQ3 Street Dash”, as this will install the necessary files needed for the IQ3 Street Dash unit.

To install the software

1. Close all/any programs before beginning the DatalinkII installation
2. Insert Racepak USB Memory Flash Drive a USB port of the Laptop/PC
3. After a few seconds, the installation program should automatically start
4. **“Welcome to the Install Wizard for DatalinkII”. Click Next**
5. **“License Agreement”**. After reading, **Click Yes**
6. **“Choose Destination Location”** Default C:\Program Files\DatalinkII, **Click Next**
7. **“Data Logger Installation and Support”**, Select the check box for **IQ3 Street Dash**, **Click Next**
8. **“Select Program Folder”**, Default is DatalinkII, **Click Next**
9. Install will start as noted by progress bar
10. Installing for the first time, a **“Welcome to the Install Wizard for PL-2303 USB-to-Serial”** window will open, **Click Next**
11. **“License Agreement”**, after reading, **Click YES**
12. Installation PL-2303 Wizard Complete, **Click Finish**
13. Installation Wizard Complete, **Click Finish**
14. DatalinkII will now open
15. Software Installation Complete

Upon completion of installation, a new shortcut icon (shown right) will be added to the PC desktop with a title “DatalinkII Program”. Double click on the icon to start the DatalinkII software.



Configuration Files

The IQ3 Street Dash unit is shipped from Racepak, with factory default settings. To modify the settings of the IQ3 Street Dash unit, most basic settings can be modified through the use of the programming buttons; however, the use of a PC/laptop allows complete access to all the available settings.

A PC/laptop must be connected to the IQ3 Street Dash in one of the two fashions shown below. A configuration file on the PC/laptop will then be opened and synced (READ from) the unit. Once the settings are read from the IQ3 Street Dash, changes are made, and SENT/WRITE back to the IQ3 Street Dash.

Stand Alone or with V-Net Sensors, No External Data Recorder

When utilizing the IQ3 Street Dash as a standalone system (i.e. **not connected** via V-Net to a compatible Racepak Data Recorder), use the factory car configuration file which was copied onto the PC during the DatalinkII software installation, listed as **IQ3_Street_Config**. This configuration file contains the setup information for the IQ3 Street Dash unit, and each of the internal channels connected to the IQ3 Street Dash unit.

1. Connect PC to IQ3 Street Dash unit using the USB programming cable supplied with the IQ3 Street Dash unit system. (The USB programming port is located on the rear of the dash).
2. Ensure the main power is turned on for the IQ3 Street Dash. The dash backlight will be on and lit when power is on.
3. Start the DatalinkII program by double clicking on the DatalinkII Program icon located on the Windows desktop of PC (shown right).
4. Open the car configuration file. To open the car configuration file, select **File** located in the main menu bar across the top of the screen and select **Open Car Configuration**. (Shown right).
5. The dialog box (shown right) will be displayed.
6. The list on the left-hand side of the **Select Configuration** dialog box will display all of the file folders in the RacePakData subdirectory (C:\RacePakData) that contain valid configuration files with a .rcg file extension. Select the IQ3 listing by selecting with the cursor.
7. The list on the right will now contain the list of configuration files contained in this folder. The factory configuration file for the IQ3 Street Dash unit will be located here. Select the OK button.

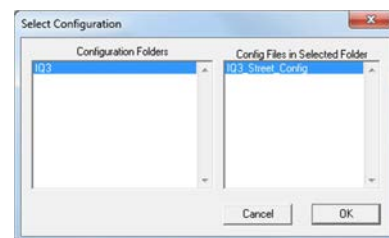
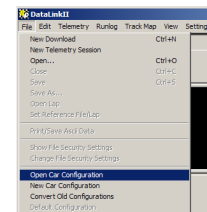

IQ3 Street Dash with Data Recorder

If utilizing the IQ3 Street Dash unit with any of the compatible Racepak Data Recorders (i.e. **connected** via V-Net to compatible Racepak data recorders), the same car configuration file utilized to program the data recorder will be also be utilized to program the IQ3 Street Dash. The IQ3 Street Dash will need to be synced into the existing car configuration file. Once READ in (synced), channel buttons for the IQ3 Street Dash unit will appear in the data recorder configuration file.

1. Connect PC to **data recorder** using the programming cable supplied with the **data recorder** system.
2. Ensure the main power is turned on for both the IQ3 Street Dash ***and/or*** data recorder. The backlight light on the IQ3 Street Dash should be lit.
3. Start the DatalinkII program by double clicking on the DatalinkII Program icon located on the Windows desktop of PC.
4. Open the car configuration file. To open the car configuration file, select **File** located in the main menu bar across the top of the screen, and select **Open Car Configuration**. (shown right).
5. The dialog box shown below will be displayed.
6. The list on the left-hand side of the **Select Configuration** dialog box will display all of the file folders in the RacePakData subdirectory (C:\RacePakData) that contain valid configuration files with a .rcg file extension. Select the item that **matches the data recorders serial number** by left clicking on it with the mouse (shown in example is **V300SD_4447**).
7. The list on the right will now show the list of configuration files contained in this folder. Select the item which **matches the data recorder serial number** by left clicking, then the OK button.

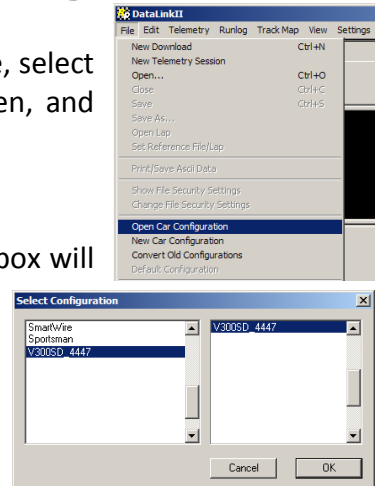

Adding the IQ3 Street Dash to Your Data Recorder Configuration File

1. Open the DataLink software and select **File** from the main menu area
2. Select **Open Car Configuration** from the pull down menu.
3. A Select Configuration dialog window will open. A list of folders containing Configuration files will appear on the left side, while the actual Configuration files appear on the right side. If you are programming the IQ3 through a Racepak data recorder, then select the appropriate configuration file for your data recorder. If you are programming the IQ3 through the serial port on the back of the dash, then select IQ3 in the left window and select IQ3_NonLogger_Config in the right window.
4. Click **Edit** on the menu bar and select **Read VNET Config**.
5. A message log will appear and should begin reading your system configuration. When finished the message log should display *******DEVICES READ SUCCESSFULLY*******.



6. Click on the OK button. You should now see a new channel button labeled IQ3 Street Dash.

Programming the Display Using the DataLink Software

Many display functions of the IQ3 Street Dash can be programmed utilizing the two external programming buttons as outlined in the Programming the Display by External Buttons section of this manual, [page 20](#). However, it is also possible to program many of these same functions along with additional functions utilizing the user's PC and DataLink program.

Com Port Settings

When using a PC to program the IQ3 Street Dash, a programming cable must be used through the serial communication port on the back of the IQ3 Street Dash. A USB programming cable is provided in your IQ3 Street Dash kit.

The DataLink software is set from the factory to communicate through COM3. If your PC is using a different COM port number, it will be necessary to match the DataLink and PC com port settings. If your IQ3 Street Dash is connected to a data logger, connect your PC to your data logger using the serial cable provide with your data logger.

1. Connect the supplied USB programming cable between your PC's USB port and the USB port located on the rear of the IQ3 Street Dash
2. Turn on the power to your Racepak unit.
3. Start the DatalinkII program by double clicking on the DatalinkII Program icon located on the Windows desktop of PC
4. Open the configuration file by clicking on **File -> Open Car Configuration**
5. Select the **IQ3** on the left pane, **IQ3_Street_Config** on the right pane and click **OK**
6. Click **Edit** on the main menu bar and select **Read VNET Config**
7. A window may appear asking if you wish to default this configuration. Select the top option to make this configuration the default for all programming operations. Should you have more than one Racepak system, you may select another option that is applicable.
8. The DataLink program will check COM ports 1-255 for the presence of a Racepak unit. If found, DataLink will automatically configure the proper COM port setting for you. If a Racepak unit was not found, and you are using a USB to Serial Port adapter, ensure that you have properly installed the device adapter driver on your PC.
9. You can also manually configure the COM port settings under **Settings -> Preferences**.

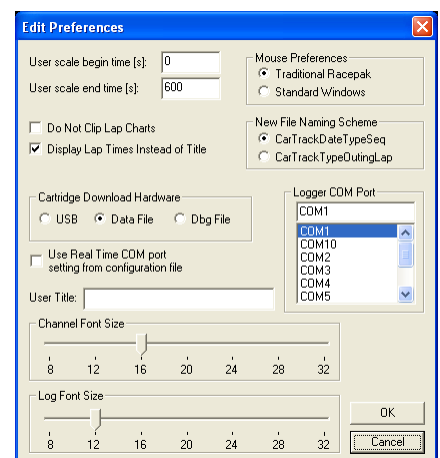

Reading/Syncing of the Configuration File

1. Open the DataLink software and select **File** from the main menu area
2. Select **Open Car Configuration** from the pull down menu.
3. A Select Configuration dialog window will open. A list of folders containing Configuration files will appear on the left side, while the actual Configuration files appear on the right side. Select **IQ3** in the left window and select **IQ3_Street_Config** in the right window.
4. Click **Edit** on the menu bar and select **Read V-NET Config**.
5. A dialog box (shown right) will appear asking if you wish to make this configuration the default configuration file. If this is the only Racepak system you will be programming, select the top option to make it the default. If using this PC to program more than one Racepak system, select the second box.
6. A message log will appear and should begin reading your system configuration. When finished the message log should display *******DEVICES READ SUCCESSFULLY*******.

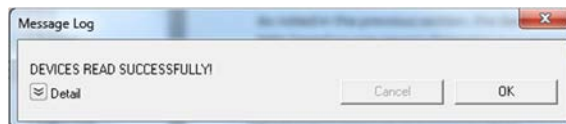
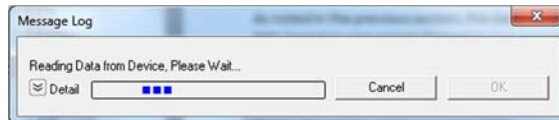

7. Click on the OK button. You should now see a new channel button for each sensor.
8. Right click on any of the channel boxes to modify/change their parameters.
9. Once any change is made, you must select **Send Configuration** to send change to the dash.

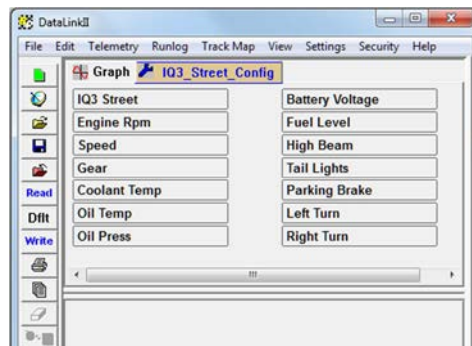

EFI Interface Programming

Once connection to your EFI system is done, you will need to activate and select your ECU within the IQ3 Street Dash Settings. This can be done by either using the pushbuttons to get into Setup Mode 1 on the dash OR connecting a PC to activate through the software. Once the ECU is selected, the Car Configuration File in your PC will need to be updated and the end user will need to select what channels are to be displayed on your IQ3 Street Dash. To perform this, follow the steps below;

1. Connect the supplied USB programming cable between your PC's USB port and the USB port located on the rear of the IQ3 Street Dash
2. Open the DataLink software and select **File** from the main menu area located across the upper area of the screen
3. Select **Open Car Configuration** from the pull down menu.
4. A Select Configuration dialog window will open. A list of folders containing Configuration files will appear on the left side, while the actual Configuration files appear on the right side. Select **IQ3** in the left window and select **IQ3_Config_Street Dash** in the right window.
5. Click **Edit** on the menu bar and select **Read V-NET Config**.
6. A dialog box (shown right) may appear asking if you wish to make this configuration the default configuration file. If this is the only Racepak system you will be programming, select the top option to make it the default. If using this PC to program more than one Racepak system, select the second box.



7. A message log will appear and should begin reading your system configuration.
8. When finished the message log should display ******DEVICES READ SUCCESSFULLY******.

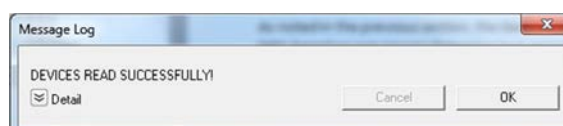

9. Click on the OK button.
 - a. If the ECU interface was turned on using the pushbuttons/Setup Mode 1 you should now see a new channel buttons (boxes) for each channel.
 - b. If the ECU interface was not previously enabled, you can do so using the pushbuttons/Setup Mode 1, and then repeat the Read process after which the new ECU channels will appear.
 - c. If the ECU interface was not previously enabled, you can do so using the DataLink Software,
 - i. navigate to the Dash Info tab by right clicking on the main channel button labeled **IQ3 Street**
 - ii. Select Dash Info tab, locate the listing ECU Type under the Custom Programming Options
 - iii. Click on ECU type and select your ECU from the drop down list on the right
 - iv. Select Send Configuration
 - v. Exit the LCD Dash Configuration window to return to the main configuration window and repeat the Read process after which the new ECU channels will appear
10. Right click on any of the channel boxes to modify/change their parameters.
11. Once any change is made, you must select **Send Configuration** to send change to the dash.
12. The channels are now ready to be selected and programmed to the Display pages.

Programming the Display Pages

Right click over the IQ3 Street Channel Button. This action opens the following window:

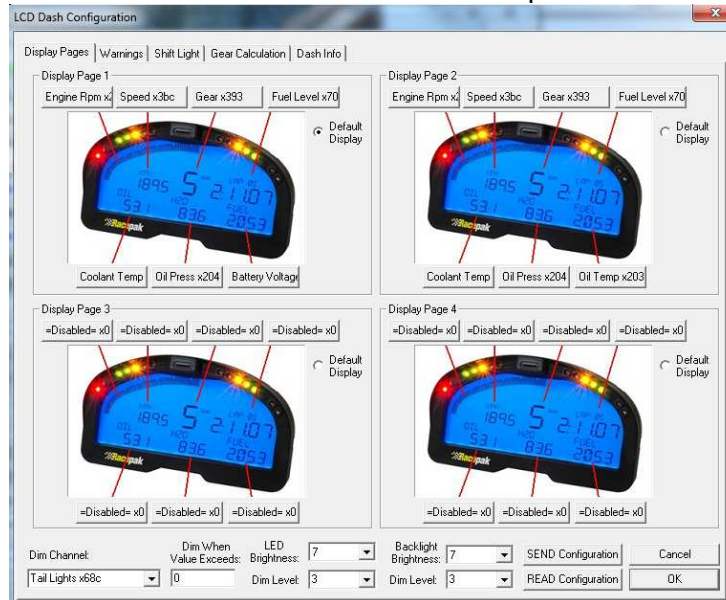

A view representing the current programming of all four display pages is obtained by selecting the Display Pages tab. Each input is programmed by selected the text box related to that input area, as indicated by the red line extending down to the dash, from each text box.

Each programming function is accessed by tabs located across the top of the page, as outlined in the following section.



All programming changes to the IQ3 Dash must be finalized by selecting the Send Configuration button found in the bottom right corner of each programming page.

Bar Graph (Sweep Tach)

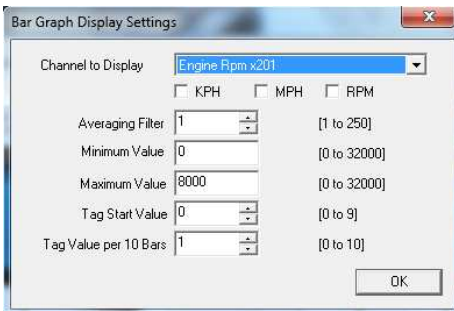

Function	Description
KPH MPH RPM	Selection defines channel name on dash
Channel to Display	Pull down arrow selects channel for bar graph data
Averaging Filter	Smooths displayed data. 10 is default
Minimum Value	Determines starting point for bar graph
Maximum Value	Determine ending point for bar graph
Tag Start Value	Determines start value for bar graph
Tag Value per 10 Bars	Determines value for each 10 bar segment. There are a total of 8, 10 bar segments for 80 total bars. Channel tag value <u>must</u> be equally divisible by the 80 bars to correspond correctly with a channel's actual reading.
OK	Closes window following programming changes

Gear Indicator (center of dash) "Gear Position"

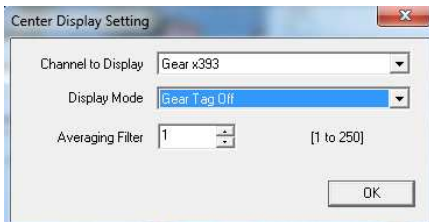

Function	Description
Channel To Display	Pull down arrow selects sensor channel
Averaging Filter	Smooths displayed data. 10 is default
Display Mode	Selects when to display the gear number in the center display.
OK	Closes window following programming changes

Remaining Inputs

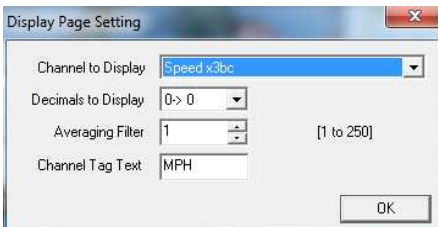

Function	Description
Channel to Display	Pull down arrow selects sensor channel
Decimals to Display	Number of digits to display after decimal
Averaging Filter	Smooths displayed data. 10 is default
Channel Tag Text	Name/channel label to be displayed. 5 total characters

As shown above, to program an input area, simply locate the desired sensor channel by use of the pull down arrow, select the sensor channel, then define the remaining values for Decimals to Display, etc.

Programming the Warnings

The IQ3 Street Dash provides the ability to program up to four individual warning channels. The face of the dash contains four warning lights. Each warning light is associated with a single warning channel. To program each individual warning channel:

1. Select the “Warnings” tab.
2. Next, left click on the warning light you would like to program. This action will open the Warning Light text box.

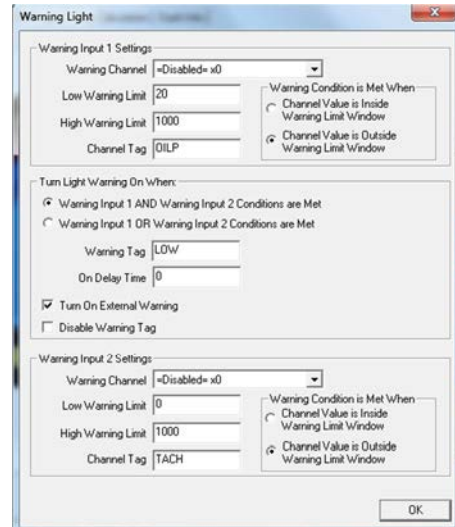

Warning Parameter	Description
Warning Channel	Sensor input to be used to trigger warning.
Low Warning Limit	Sensor value to trigger warning when below this value.
High Warning Limit	Sensor value to trigger warning when above this value.
Channel Tag	Text to be displayed above warning channel value when warning is activated. 5 chars max.
Channel Value is Inside Warning Limit Window	Triggers warning when sensor value is between Low and High Warning limits.
Channel Value is Outside Warning Limit Window	Triggers warning when sensor value is below Low Warning Limit and above High Warning Limit.
Warning Input 1 AND Warning Input 2 Conditions Are Met	Requires that warning 1 AND warning 2 conditions are met to activate warning.
Warning Input 1 OR Warning Input 2 Conditions Are Met	Requires that warning 1 OR warning 2 conditions are met to activate warning.
Warning Tag	Text displayed to the left of warning channel value(s) when warning is activated. 5 chars max.
On Delay Time	Time in seconds to delay before warning is activated.
Turn On External Warning	Turns on external warning when warning channel is activated.

Example Warning Setup

As noted in the previous section, the dash warning setup allows the user to trigger a warning light based on one sensor channel or two sensor channels. In addition, a specific text warning may be programmed to display when the warning parameters are met.

In the example setup below, the dash warning was programmed as follows:

Warning Channel One: Oil Pressure below 30 PSI
Text Above Warning Channel One: OIL
Warning Channel Two: Engine RPM above 1000
Text Above Warning Channel Two: TACH
Text To Display When Warning Values Are Met: Oil P

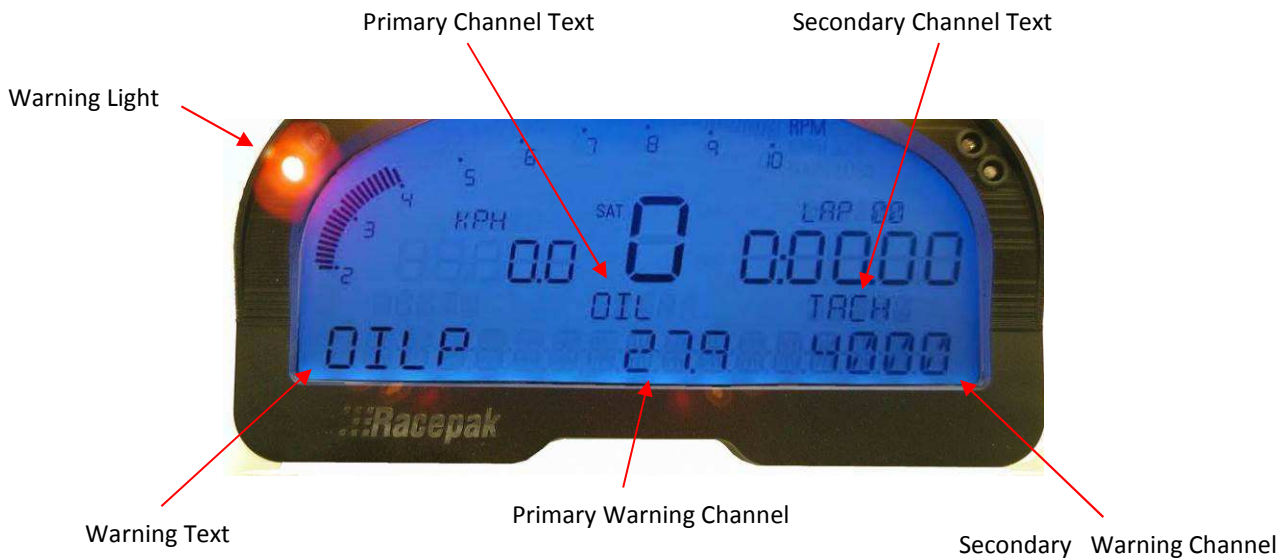

When at least one programmed warning channel is activated, the warning text will alternate between the warning channel data and the normal display page data once per second.

To clear ALL active warnings, enter a SHORT press on Programming Button 1. This will clear the warnings until the warning channel goes out of warning and then back into to warning again.

Shift Lights

To program the shift lights, simply determine the RPM Channel to activate the shift lights (typically Engine RPM) then select the shift point for each gear. Finally, select the RPM Interval between each shift light.

Example: Shift point for each gear is 5000 RPM. Interval is 100 RPM. With 5 shift lights in use (10 total lights that are displayed two at a time), the software will calculate back from the programmed shift point and start the shift lights at 4600 RPM and increment to 4700, 4800, 4900 and with all lights on at 5000.

Shift Light Formula: Shift Light Interval x 4 minus Shift Point = Starting Point of Shift Lights
 100 x 4 = 400. 5000 – 400 = 4600 (start of shift lights)

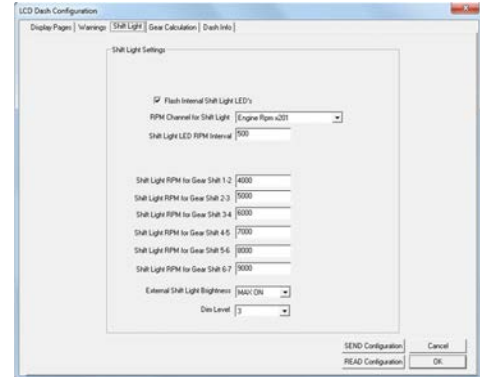

Gear Calculation

The gear position is most easily configured using the IQ3 Setup Mode 2 programming. The IQ3 derives the gear position by calculating the ratio between the engine rpm and speed at the time each gear is programmed. The selected speed channel is also used to maintain the odometer.

It is also possible to manually enter the ratio values using the Gear Calculation tab. However, the ratio value is not the transmission or final drive ratio, but instead is the ratio between engine rpm and speed. DataLink can calculate these ratios for you by entering the transmission ratio for each gear and the final drive ratio in the transmission for FWD vehicles or differential gear ratio RWD vehicles. Enter the tire rollout in inches if the speed channel you have selected is in MPH units. Enter the tire rollout in centimeters if the speed channel you have selected is in KPH units and check the “Speed Units in KPH” box. Uncheck all unused gears to disable them. After you have entered all of the required information, click the “Calc” button to calculate and fill in the RPM/Speed ratios. Click the “SEND Configuration” to program the ratios in to the IQ3.

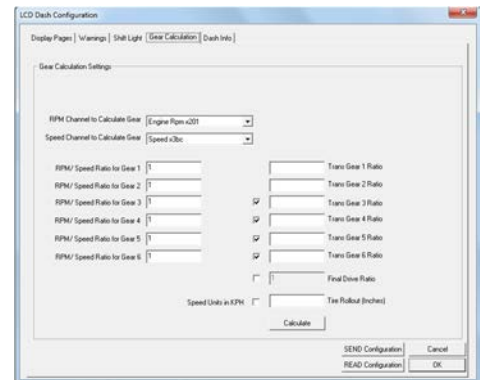

⚠ Since only the RPM/Speed ratio values are programmed in to the IQ3, the transmission ratios and tire rollout values are not saved in the DataLink configuration file. You will need to reenter these values each time you need to make a change. The formula used to calculate the RPM/Speed ratio when speed in in MPH units is shown below.

$$1 / ((\text{Tire Rollout} / 12 * 60 / 5280) / (\text{Gear Ratio (n)} * \text{Final Drive Ratio})) = \text{RPM/Speed Ratio for Gear(n)}$$

Example: using 90” tire rollout, 3.41 1st gear ratio, 3.50 Final Drive Ratio (Differential gear)
 $1 / ((90 / 12 * 60 / 5280) / (3.41 * 3.50)) = 1 / (.08522 / 11.935) = 1 / .007140 = \mathbf{140.05 \text{ Gear 1 Value}}$

Dash Info Tab

The Dash Info contains setup parameters specific to the dash. Locate the Custom Programming Options area. This is found on the left side of the page.

To change any of the following parameters, place the mouse cursor on the desired text line and left click. This will activate the input box for the particular setting to the right of the selected text line. Changes are entered in the input box and then sent to the dash via the SEND Configuration button as found in the lower right corner of the open window.

In most instances, these settings are also accessed by the external programming buttons

IQ3 Street

Product type, do not change

ECU Type

Used to enable the ECU input, this selection will need to be enabled by selecting the appropriate ECU, from the ECU Type dropdown box. This setting can also be changed via Setup Mode 1 using the external programming buttons.

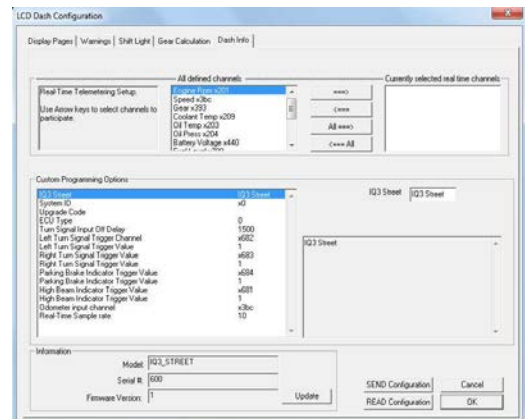

Turn Signal Input Off Delay

This setting controls that amount of time, in milliseconds, that the turn signal indicator is turned off when power is removed from the input wire controlling that indicator. Depending on the vehicle, this value may need to be changed.

Odometer Input Channel

If you would like to enable the odometer function, you must first define the speed channel used to calculate the distance traveled. If utilizing a GPS module for speed input, you must remember that the odometer will only be functional when the IQ3 Street Dash has acquired three or more satellites.

Dash Model

Dash model

Dash Serial

Serial number for product

Firmware Version

Firmware version for connected product. Updates, when available, are posted at <http://www.racepak.com/downloads/>

Troubleshooting and FAQ

The IQ3 Street Dash is designed to provide trouble free performance. At times, problems could be encountered that may affect data. We have attempted to provide answers for some of the most common questions and problems.

DataLink will not communicate with the IQ3 Street Dash when using the USB programming cable

The IQ3 Street Dash contains a built-in USB adapter that allows it to communicate using a COM port connection with its USB cable.

Verify the correct COM port of the user's PC is selected. To perform this procedure:

- A. Connect the USB cable between the IQ3 Street Dash and your PC
- B. Turn on the power to the IQ3 Street Dash and wait 5 seconds
- C. Locate the Device Manager within Windows
- D. Locate Ports (COM & LPT) in the list
- E. Select the + or ▼ to expose dropdown list
- F. Ensure the Racepak USB Device is listed and a COM number is listed
 - i. If no listing is found, check power on dash and ensure the DataLink software was properly installed as the USB driver is installed during the software installation.
 - ii. If listing is shown, note the COM number and exit the device manager
- G. Open DataLink software, go to Settings->Preferences within the Menu Bar
- H. Select matching COM port number from the Logger COM Port setting

V-Net Sensor Channels "lock up" from time to time

If a V-Net channel is subjected to excessive electrical interference, the channel will shut down for a period of time, then re-set and start displaying again. Ensure none of the V-Net modules or cables are against or in the immediate area of ignition system components.

Conclusion

We hope this manual has proved helpful to your entry into the usage of the Racepak IQ3 Street Dash. While the knowledge gained from our data system will provide a benefit to any race team. Taking the time and effort to learning how to utilize the system will prove most beneficial.

As with any endeavor, the work invested in properly learning the usage of the product will pay dividends in the customer's satisfactory. There are a variety of books available concerning the data analysis. Take time to locate and read of the manuals to learn the proper method of utilizing the product.

As always, if there are any questions concerning any aspect of the system, please feel free to contact the Racepak support personnel at 949-709-5555.

Thank you,

Racepak Data Systems
The logo for Racepak Data Systems features the word "RACEPAK" in a bold, italicized, yellow font with a black outline. To the left of the text is a graphic element consisting of a grid of small squares, some of which are filled with yellow, creating a stylized representation of a race track or data points.